

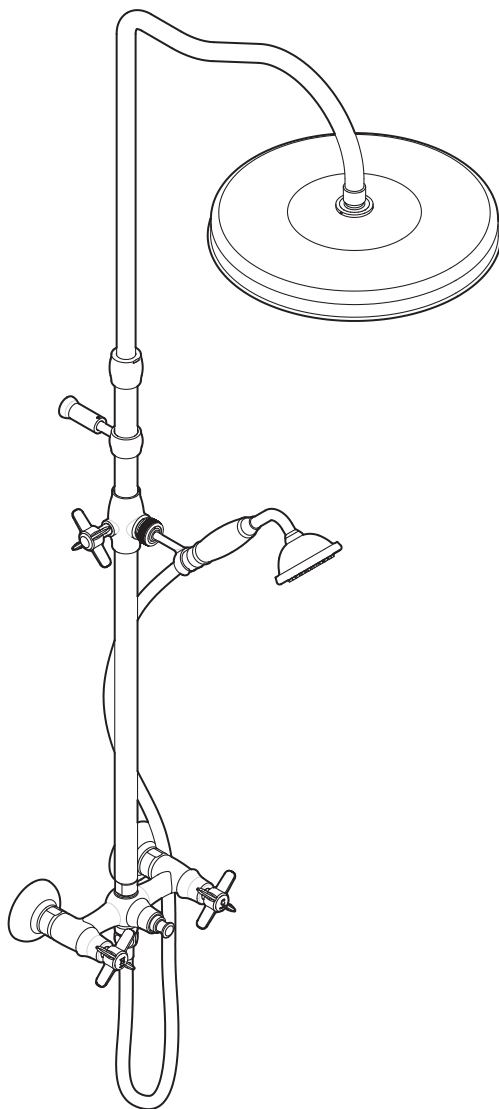





TRES

Ref. 193619102 • ed. 11AF

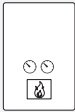
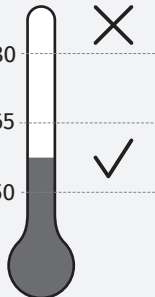

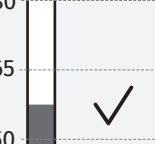
EL INCUMPLIMIENTO DE ESTAS INSTRUCCIONES EXIME DE TODA RESPONSABILIDAD A TRES GRIFERÍA • L'INCOMPLIMENT D'AQUESTES INSTRUCCIONS EXIMEIX DE TOTA RESPONSABILITAT A TRES GRIFERÍA • LE NON-RESPECT DE CES INSTRUCTIONS DÉGAGE TRES GRIFERÍA DE TOUTE RESPONSABILITÉ • DIE MISSACHTUNG DIESER ANWEISUNGEN BEFREIT TRES GRIFERÍA VON JEDLICHER HAFTUNG • NIET-NALEEVING VAN DEZE INSTRUCTIES ONTSLAAT TRES GRIFERÍA VAN ALLE VERANTWOORDELIJKHEID • L'INADEMPIMENTO DELLE PRESENTI INDICAZIONI ESONERA TRES GRIFERÍA DA QUALSIASI RESPONSABILITÀ • TRES GRIFERÍA NENESE ODPOVĚDNOST ZA ŠKODY ZPŮSOBENÉ NEDODRŽENÍM UVEDENÝCH POKYŇŮ • THE NON-FULFILMENT OF THESE INSTRUCTIONS SHALL EXEMPT TRES FROM ALL AND ANY LIABILITY • NIEPRZESTRZEGANIE NINIEJSZYCH INSTRUKCJI ZWALNIA FIRMĘ TRES GRIFERÍA Z WSZELKIEJ ODPOWIEDZIALNOŚCI • O INCUMPRIMENTO DESTAS INSTRUÇÕES ISENTA A TRES GRIFERÍA DE QUALQUER RESPONSABILIDADE • НЕСОБЛЮДЕНИЕ ДАННЫХ ИНСТРУКЦИЙ ВЛЕЧЕТ ЗА СОБОЙ ОСВОБОЖДЕНИЕ КОМПАНИИ TRES GRIFERÍA ОТ ЛЮБОЙ ОТВЕТСТВЕННОСТИ

VALORES DE CONEXIÓN • VALORS DE CONNEXIÓ • VALEURS DE BRANCHEMENT • ANSCHLUSSWERTE •
 WAARDEN VAN DE VERBINDING • VALORI DI CONNESSIONE • NASTAVENÍ PŘIPOJENÍ • FITTING CONNECTION
 SPECIFICATIONS • CHARAKTERYSTYKI PODŁĄCZENIA • CONDIÇÕES DE CONEXÃO • ПРОМЫВКА СИСТЕМЫ

			
			
			

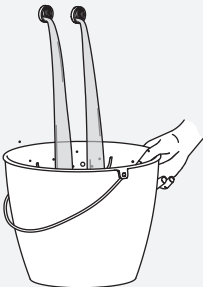

INSTALACIÓN • INSTALLATION • INSTALLATION • INSTALLATIE • INSTALLAZIONE • INSTALACE • INSTALLATION •
 MONTÁŽ • INSTALAÇÃO • УСТАНОВКА

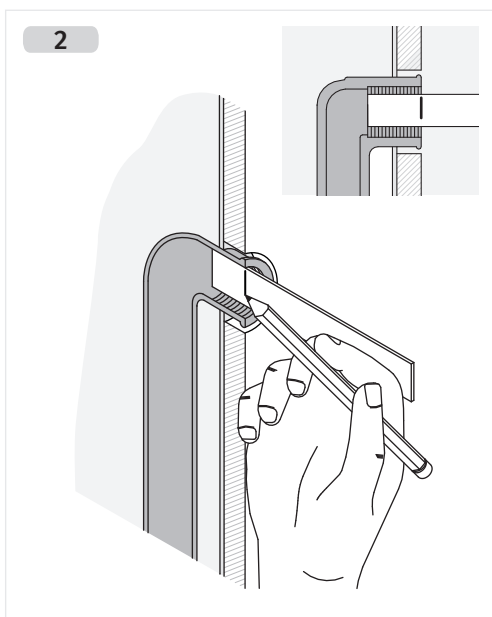
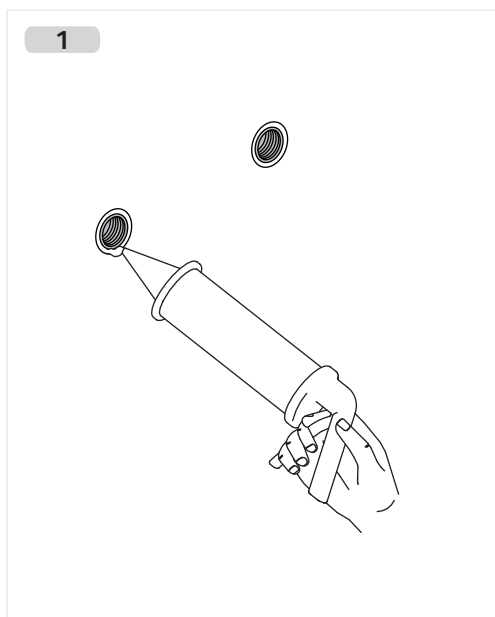

3

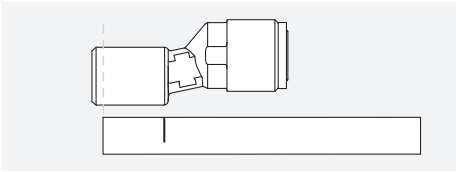
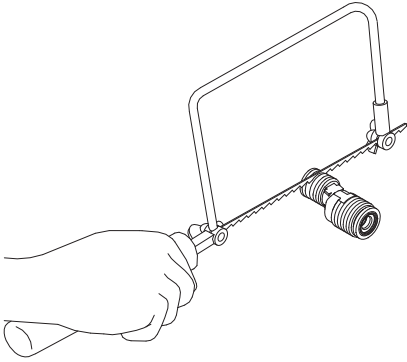

4

15

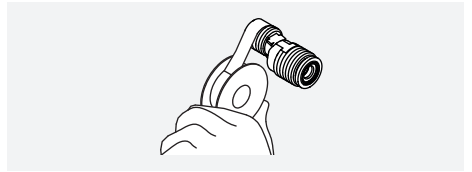
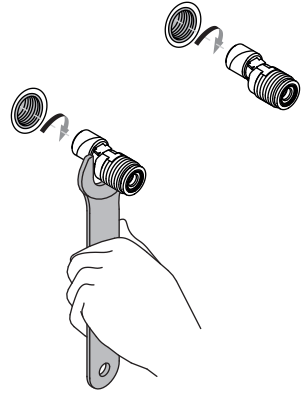

5

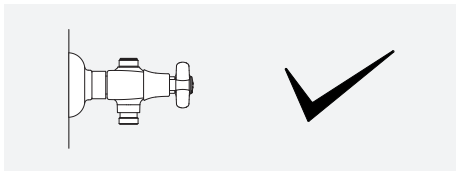
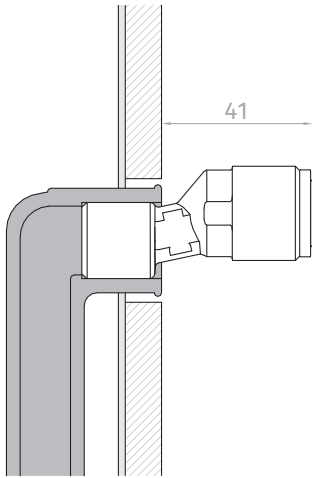

6

30

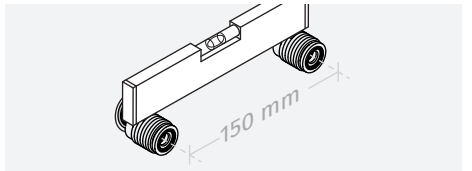
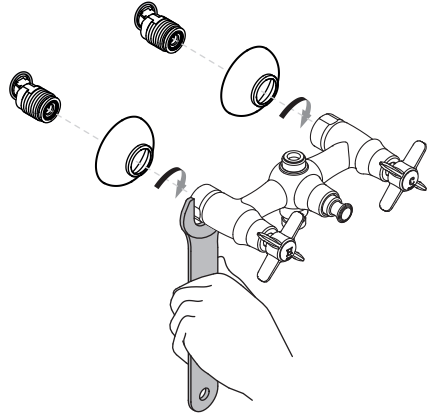

7

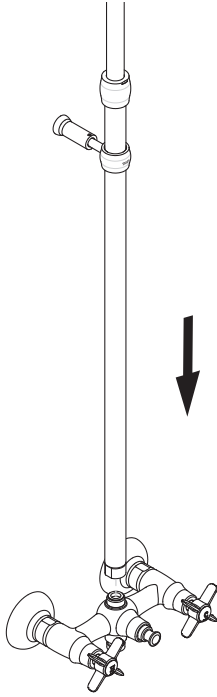

8

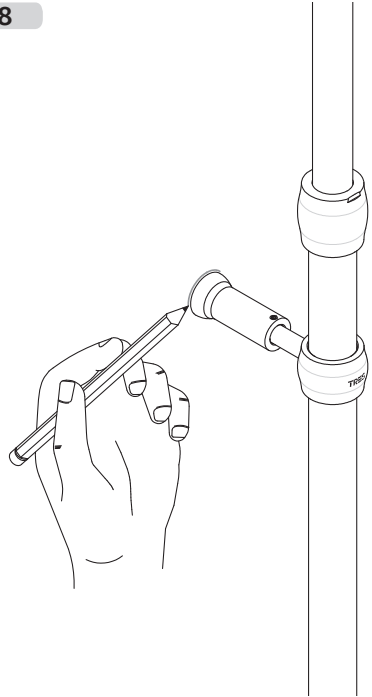

9

Ø 8

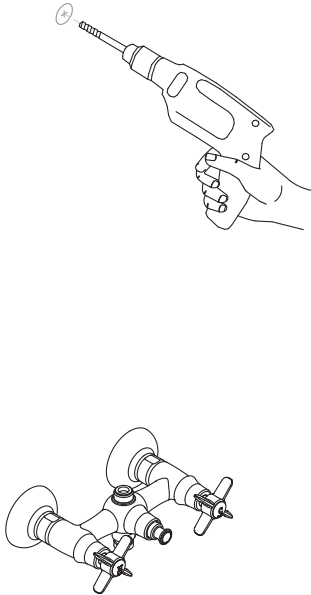

10

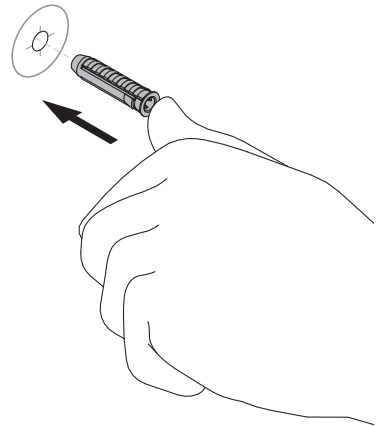

11

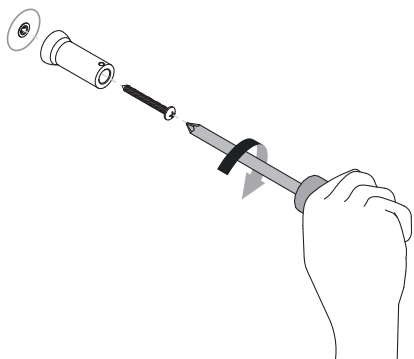

12

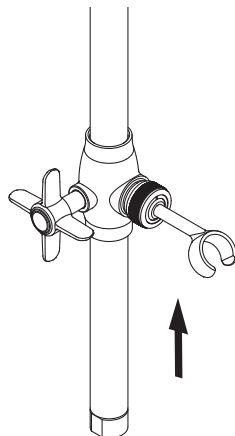

13

⬡ 22

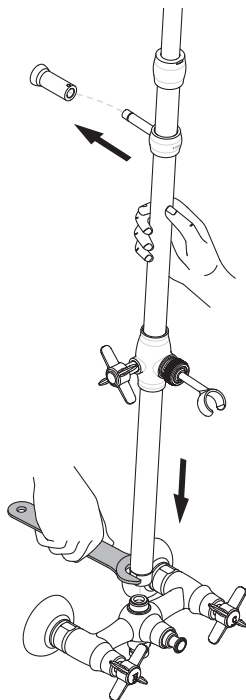

14

⬡ 2

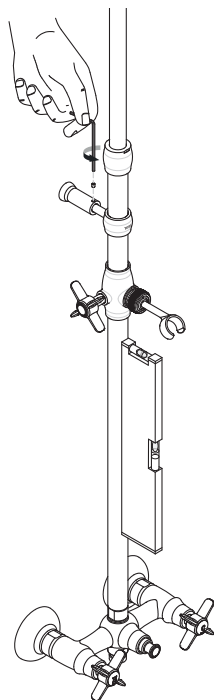

15

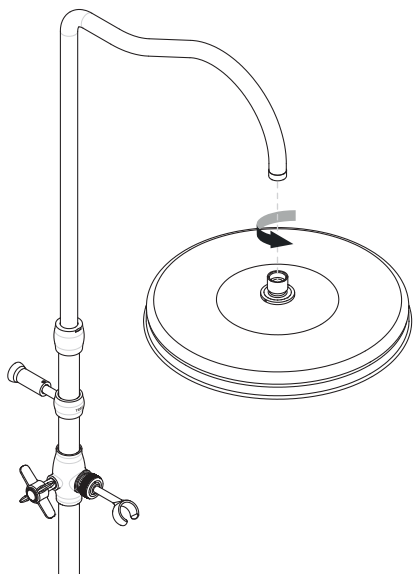

16

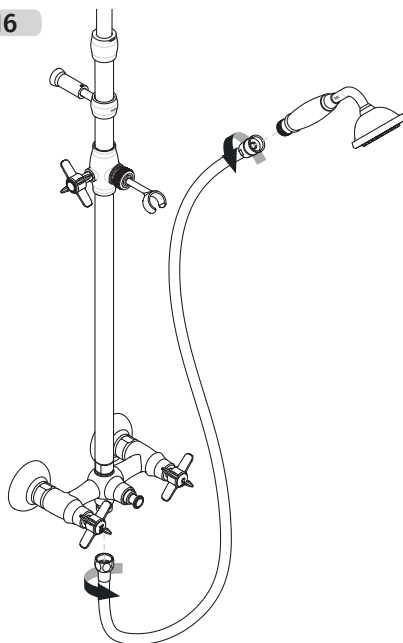

ACCESO A LA MONTURA • ACCÈS À LA MONTURE • ZUGRIFF AUF DIE BEFESTIGUNG • TOEGANG TOT HET MONTUUR •
 VALVE CARTRIDGE ACCESS • ACCESSO A LA MONTATURA • SNADNÝ PŘÍSTUP K MONTÁŽI • ACESSO À ARMAÇÃO •
 DOSTĘP DO ELEMENTÓW MONTAŻOWYCH • Доступ к кран-буксе

1

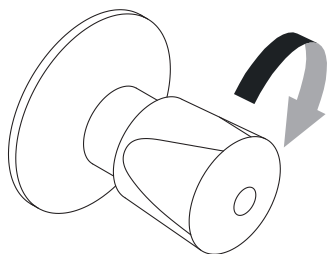

2

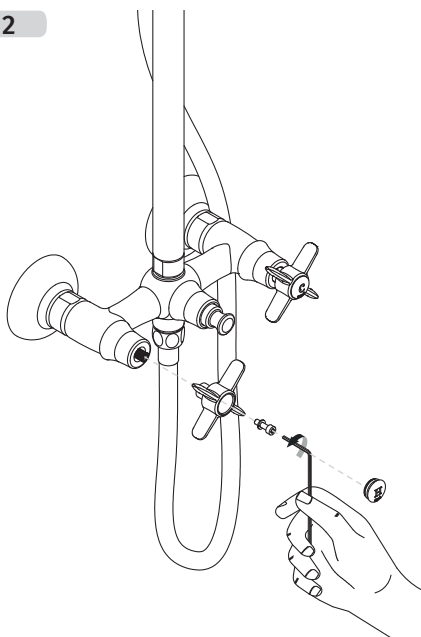

3

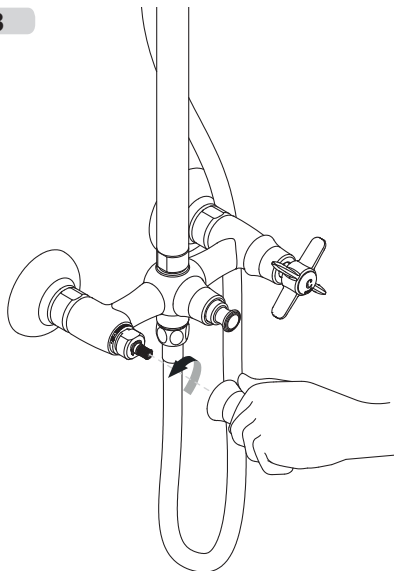

4

18

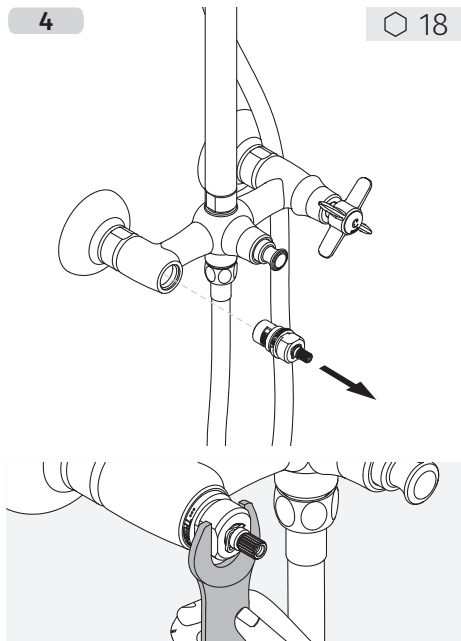

MANTENIMIENTO • ENTRETIEN • WARTUNG • ONDERHOUD • MANUTENZIONE • ÚDRŽBA • MAINTENANCE •
KONSERWACJA • MANUTENÇÃO • ТЕХНИЧЕСКАЯ ПОДДЕРЖКА

1

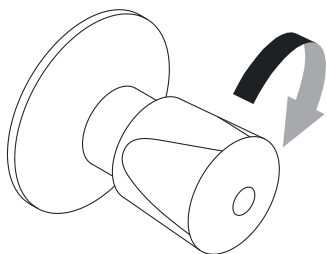

2

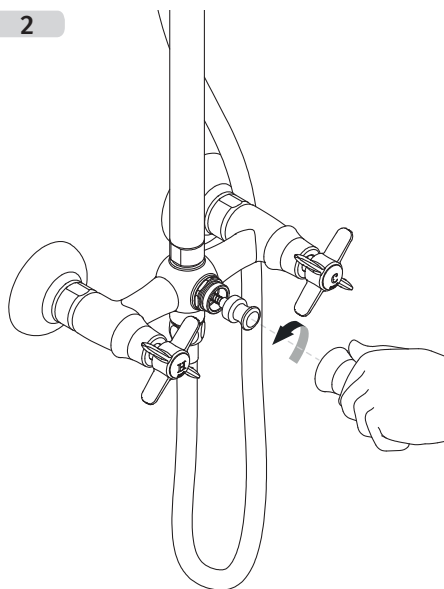

3

24

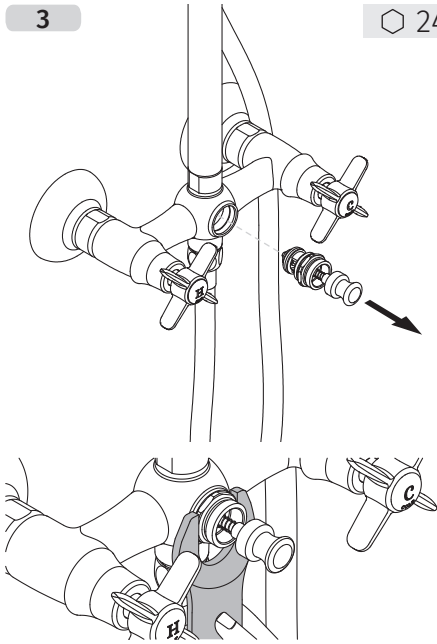

4

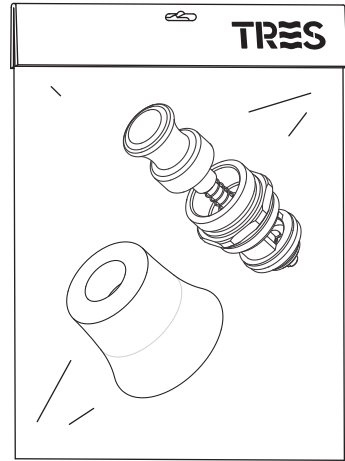

www.tresgriferia.com

LIMPIEZA • NETEJA • NETTOYAGE • REINIGUNG • REINIGING • PULIZIA •
 ČIŠTĚNÍ • CLEANING • CZYSZCZENIE • LIMPEZA • ЧИСТКА

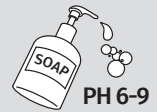

TRES

TRES COMERCIAL, SA | C/ Penedès, 16-26 · Zona Industrial, Sector A · 08759 Vallirana
 comercialtres@tresgriferia.com · (+34) 93 683 40 27 · www.tresgriferia.com